

Small Signal Schottky Diode

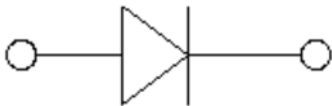

Features

- Moisture sensitivity level 1
- Reverse voltage: 40V/30V/20V
- Average forward current : 350mA

Application

- High frequency and low voltage rectifier

Mechanical data

- **Package:** SOD-323
- **Terminals:** Tin plated leads, solderable per J-STD-002 and JESD22-B102

■ Maximum Ratings (T_a=25°C Unless otherwise specified)

Parameter	Symbol	Unit	Value	
Device marking code			SD103AWS	S4
			SD103BWS	S5
			SD103CWS	S6
Forward current	I _F	mA	350	
Non-repetitive surge peak forward current @ t=8.3ms half-sine wave	I _{FSM}	A	1.5	
Non-repetitive surge peak forward current @ t=1ms square wave			5	
Power dissipation	P _D	mW	200	
Junction temperature	T _J	°C	-55 to +125	
Storage temperature	T _{STG}	°C	-55 to +150	



SD101AWS THRU SD101CWS

RoHS
COMPLIANT

■ Electrical Characteristics (T_a=25°C Unless otherwise specified)

Parameter	Symbol	Unit	Conditions		Min	Typ	Max
Reverse voltage	V _R	V	SD103AWS	I _R =100uA	40		
			SD103BWS		30		
			SD103CWS		20		
Forward voltage	V _{F1}	V	I _F =20mA				0.37
	V _{F2}	V	I _F =200mA				0.60
Reverse leakage current	I _R	uA	SD103AWS	V _R =30V			5
			SD103BWS	V _R =20V			5
			SD103CWS	V _R =10V			5
Junction capacitance	C _j	pF	V _R =0V, f =1MHZ				50

■ Thermal Characteristics

Parameter	Symbol	Unit	Value
Thermal resistance, junction-to-ambient	R _{θJ-A} ⁽¹⁾	°C/W	500
Thermal resistance, junction-to-case	R _{θJ-C} ⁽¹⁾	°C/W	400

Note:

(1) Thermal resistance from junction to ambient and from junction to case mounted on P.C.B. with 8mm*9mm copper pad areas



■ Characteristics

Fig 1: P_D - T_a Curve

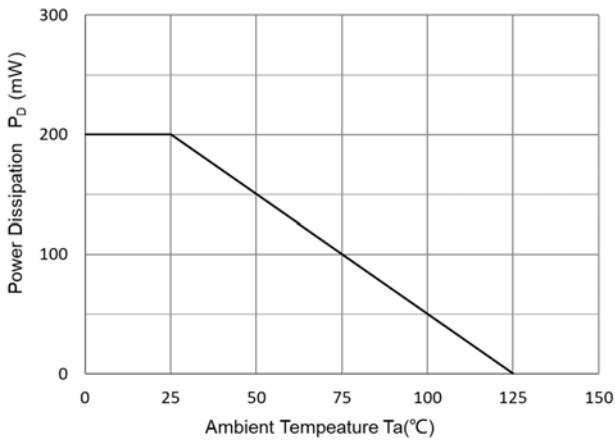

Fig 2: Capacitance Capability

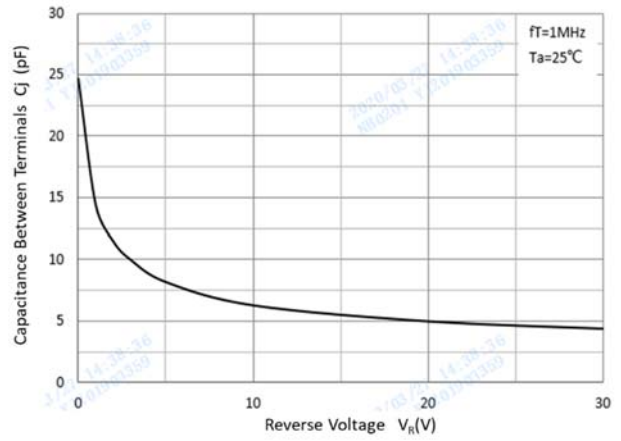

Fig 3: Typical Forward Characteristics

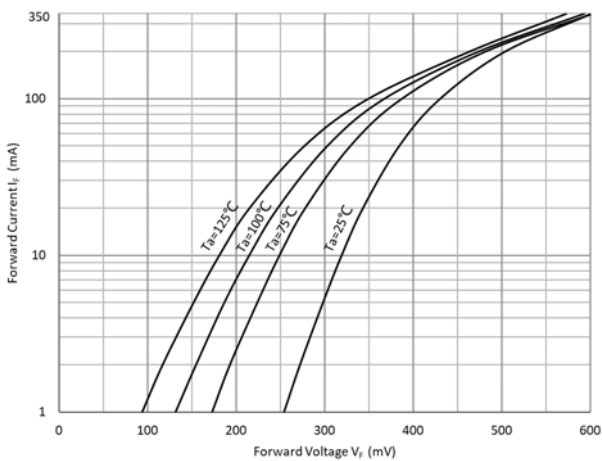
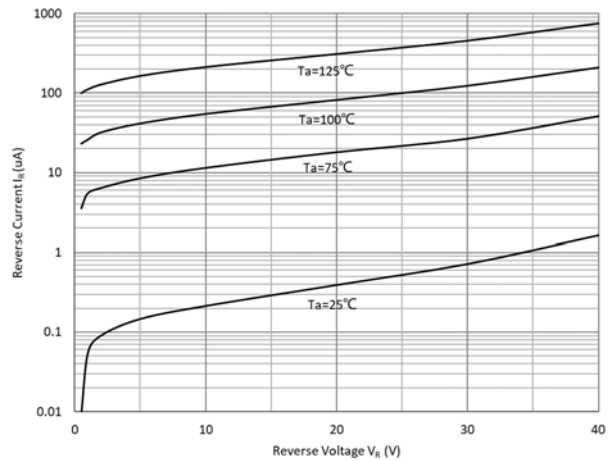

Fig 4: Typical Reverse Characteristics





SD101AWS THRU SD101CWS

RoHS
COMPLIANT

Ordering Information

Preferred P/N	Packing code	Unit weight(g)	Minimum package(pcs)	Inner box quantity(pcs)	Outer carton quantity(pcs)	Delivery mode
SD103AWS THRU SD103CWS	F2	Approximate 0.0048	3000	30000	120000	7" reel
SD103AWS THRU SD103CWS	F3	Approximate 0.0048	10000	/	210000	13" reel

Outline Dimensions

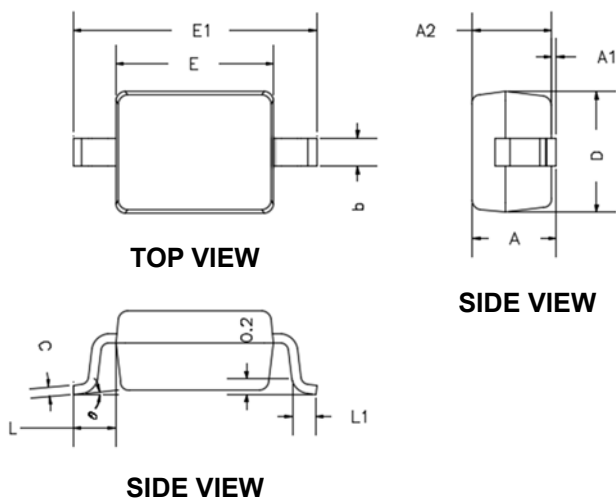

DIMENSIONS				
DIM	INCHES		MM	
	MIN	MAX	MIN	MAX
A	---	0.0393	---	1.0000
A1	0.0000	0.0039	0.0000	0.1000
A2	0.0314	0.0354	0.8000	0.9000
b	0.0098	0.0157	0.2500	0.4000
c	0.0031	0.0059	0.0800	0.1500
D	0.0472	0.0551	1.2000	1.4000
E	0.0629	0.0709	1.6000	1.8000
E1	0.0984	0.1063	2.5000	2.7000
L	0.0187TYP		0.475TYP	
L1	0.0098	0.0157	0.250	0.400
e	0°	8°	0°	8°

Suggested Pad Layout

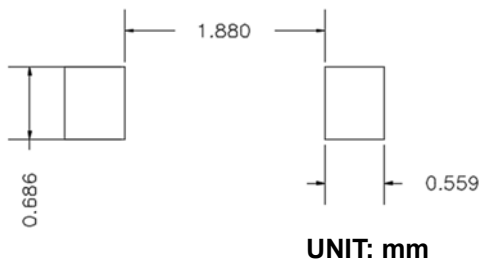



Disclaimer

The information presented in this document is for reference only. Yangzhou Yangjie Electronic Technology Co., Ltd. reserves the right to make changes without notice for the specification of the products displayed herein to improve reliability, function, or design or otherwise.

The product listed herein is designed to be used with ordinary electronic equipment or devices, and not designed to be used with equipment or devices which require high level of reliability and the malfunction of which would directly endanger human life (such as medical instruments, transportation equipment, aerospace machinery, nuclear-reactor controllers, fuel controllers and other safety devices), Yangjie or anyone on its behalf, assumes no responsibility or liability for any damages resulting from such improper use of sale.

This publication supersedes & replaces all information previously supplied. For additional information, please visit our website [http:// www.21yangjie.com](http://www.21yangjie.com) , or consult your nearest Yangjie's sales office for further assistance.